

Environmental product declaration

in accordance with ISO 14025 and EN 15804+A2

ATK

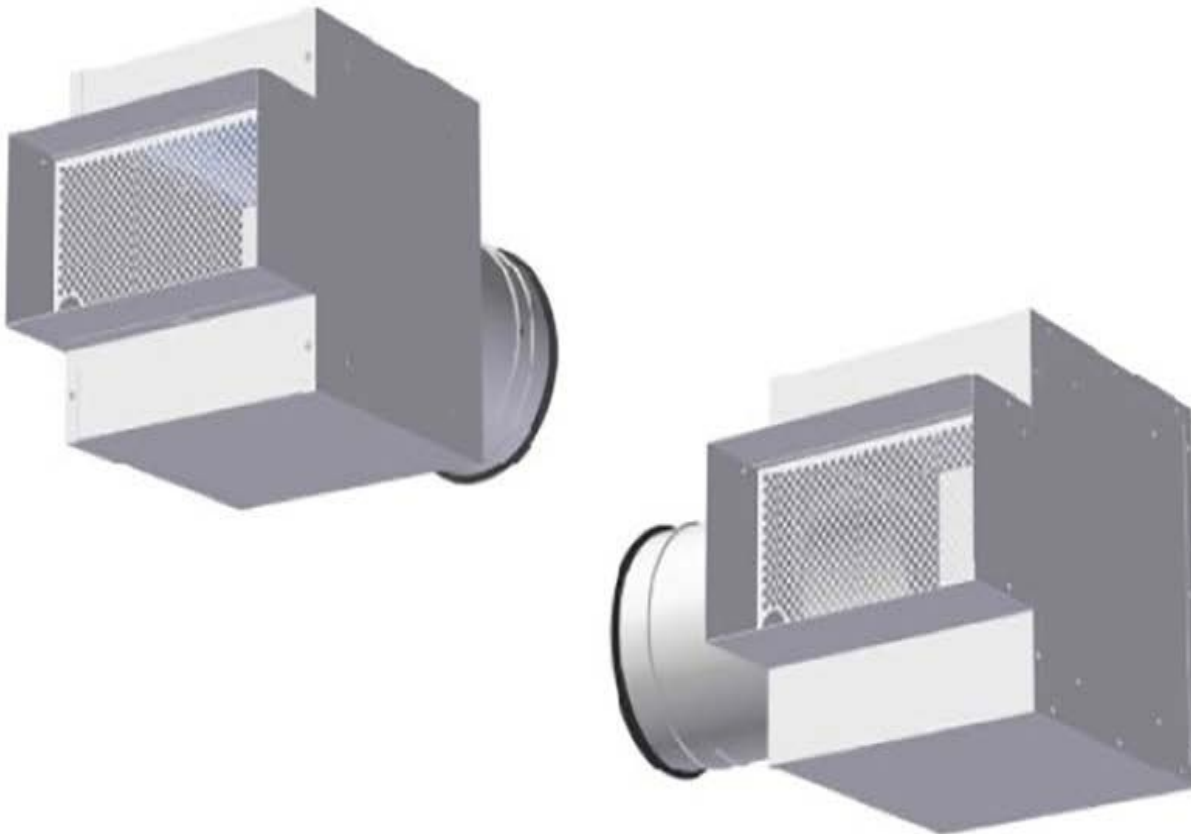

TROX

The Norwegian EPD Foundation

Owner of the declaration:

TROX Auranor AS

Product:

ATK

Declared unit:

1 pcs

This declaration is based on Product Category Rules:

CEN Standard EN 15804:2012+A2:2019 serves as core PCR

NPCR 030:2021 Part B for ventilation components

Program operator:

The Norwegian EPD Foundation

Declaration number:

NEPD-7240-6636-EN

Registration number:

NEPD-7240-6636-EN

Issue date: 15.08.2024

Valid to: 15.08.2029

EPD software:

LCAno EPD generator ID: 504965

General information

Product

ATK

Program operator:

The Norwegian EPD Foundation
Post Box 5250 Majorstuen, 0303 Oslo, Norway
Phone: +47 977 22 020
web: www.epd-norge.no

Declaration number:

NEPD-7240-6636-EN

This declaration is based on Product Category Rules:

CEN Standard EN 15804:2012+A2:2019 serves as core PCR
NPCR 030:2021 Part B for ventilation components

Statement of liability:

The owner of the declaration shall be liable for the underlying information and evidence. EPD Norway shall not be liable with respect to manufacturer information, life cycle assessment data and evidences.

Declared unit:

1 pcs ATK

Declared unit with option:

A1-A3,A4,C1,C2,C3,C4,D

Functional unit:

ATK is a chamber that is used to provide better sound attenuation and control options.

General information on verification of EPD from EPD tools:

Independent verification of data, other environmental information and the declaration according to ISO 14025:2010, § 8.1.3 and § 8.1.4. Verification of each EPD is made according to EPD-Norway's guidelines for verification and approval requiring that tools are i) integrated into the company's environmental management system, ii) the procedures for use of the EPD tool are approved by EPD-Norway, and iii) the process is reviewed annually by an independent third party verifier. See Appendix G of EPD-Norway's General Programme Instructions for further information on EPD tools

Verification of EPD tool:

Independent third party verification of the EPD tool, background data and test-EPD in accordance with EPD-Norway's procedures and guidelines for verification and approval of EPD tools.

Third party verifier:

Alexander Borg, Asplan Viak AS

(no signature required)

Owner of the declaration:

TROX Auranor AS
Contact person: Ann Lill Rønning
Phone: +47 61 31 35 00
e-mail: office-no@troxgroup.com

Manufacturer:

TROX Auranor AS

Place of production:

TROX Auranor AS
Auranorvegen 6
2770 Jaren, Norway

Management system:

Miljøfyrtårn

Organisation no:

976 699 963

Issue date:

15.08.2024

Valid to:

15.08.2029

Year of study:

2021

Comparability:

EPD of construction products may not be comparable if they not comply with EN 15804 and seen in a building context.

Development and verification of EPD:

The declaration is created using EPD tool lca.tools ver EPD2022.03, developed by LCA.no. The EPD tool is integrated in the company's management system and has been approved by EPD Norway. NEPDT46 VKEs EPD-generator

Developer of EPD: Ann Lill Rønning

Reviewer of company-specific input data and EPD: Svein Hvalstad

Approved:

Håkon Hauan
Managing Director of EPD-Norway

Product

Product description:

ATK is a chamber that is used to provide better sound attenuation and control options. The chamber is a rectangular chamber with a removable damper that provides access to a connection. ATK-B, S and LS have measuring outlets. The chamber is insulated with a polyester sound absorber.

Product specification

This EPD is made for ATK 400 x 150 ø250.

If you want values for other dimensions, you must use the factors in the table under technical data.

Materials	kg	%
Filter, plastic based	0,53	7,10
Metal - Steel	6,87	91,97
Plastic - Polyethylene (HDPE)	0,05	0,67
Rubber, synthetic	0,02	0,27
Total	7,47	100,00

Packaging	kg	%
Packaging - Cardboard	0,26	14,13
Packaging - Pallet	1,56	84,78
Packaging - Plastic	0,02	1,09
Total incl. packaging	9,31	100,00

Technical data:

For technical data see:

https://cdn.trox.de/b7107b2ff895bf95/d771138af037/GB0416-UPK_ATK.pdf

The distribution of materials in the products is almost identical, only the total weight varies.

The EPD is made for ATK 400 x 150 ø250. The factors in the table below can be used to scale LCA data for a new dimension.

Product	Weight (kg)	Factor
ATK 200x100 ø125	2,23	0,30
ATK 300x100 ø160	3,39	0,45
ATK 400x100 ø160	3,89	0,52
ATK 500x100 ø200	6,91	0,93
ATK 300x150 ø200	5,17	0,69
ATK 400x150 ø250	7,48	1
ATK 500x150 ø250	8,47	1,13
ATK 400x200 ø250	7,47	1
ATK 500x200 ø315	10,56	1,41
ATK 600x200 ø315	11,69	1,56
ATK 500x300 ø315	10,50	1,41
ATK 600x300 ø315	11,59	1,55

Market:

Europe

Reference service life, product

30 year

Reference service life, building or construction works

60 year

LCA: Calculation rules

Declared unit:

1 pcs ATK

Cut-off criteria:

All major raw materials and all the essential energy is included. The production processes for raw materials and energy flows with very small amounts (less than 1%) are not included. These cut-off criteria do not apply for hazardous materials and substances.

Allocation:

The allocation is made in accordance with the provisions of EN 15804. Energy, water and waste production in-house is allocated equally among all products through mass allocation. Effects of primary production of recycled materials is allocated to the main product in which the material was used. The recycling process and transportation of the material is allocated to this analysis.

Data quality:

Specific data for the product composition are provided by the manufacturer. The data represent the production of the declared product and were collected for EPD development in the year of study. Background data is based on EPDs according to EN 15804 and different LCA databases. The data quality of the raw materials in A1 is presented in the table below.

Materials	Source	Data quality	Year
Filter, plastic based	Modified ecoinvent 3.6	Database	2019
Metal - Steel	ecoinvent 3.6	Database	2019
Packaging - Cardboard	ecoinvent 3.6	Database	2019
Packaging - Pallet	Modified ecoinvent 3.6	Database	2019
Packaging - Plastic	ecoinvent 3.6	Database	2019
Plastic - Polyethylene (HDPE)	ecoinvent 3.6	Database	2019
Rubber, synthetic	ecoinvent 3.6	Database	2019

System boundaries (X=included, MND=module not declared, MNR=module not relevant)

Product stage			Construction installation stage	Use stage								End of life stage				Beyond the system boundaries
Raw materials	Transport	Manufacturing	Transport	Assembly	Use	Maintenance	Repair	Replacement	Refurbishment	Operational energy use	Operational water use	De-construction demolition	Transport	Waste processing	Disposal	Reuse-Recovery- Recycling-potential
A1	A2	A3	A4	A5	B1	B2	B3	B4	B5	B6	B7	C1	C2	C3	C4	D
X	X	X	X	MND	MND	MND	MND	MND	MND	MND	MND	X	X	X	X	X

System boundary:

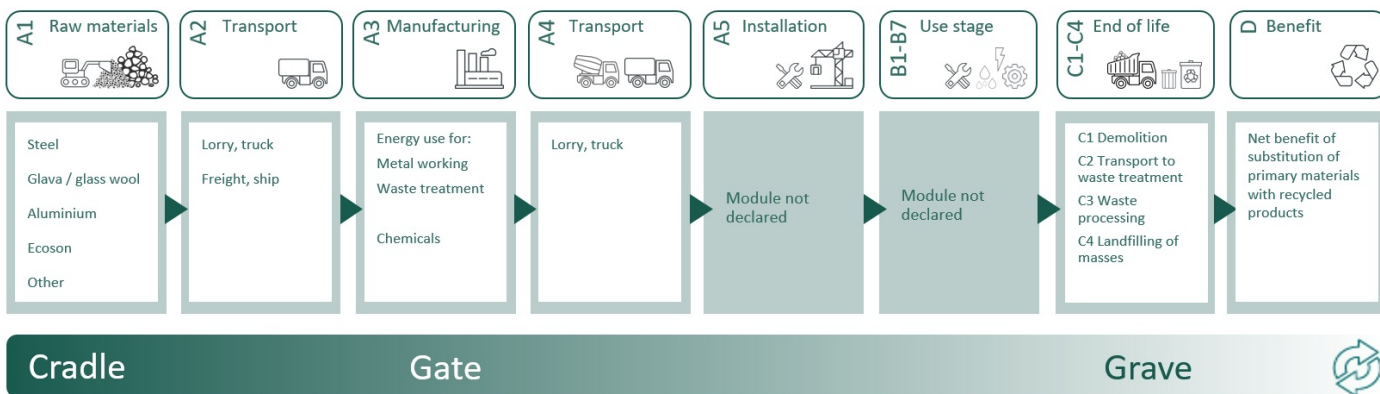

Additional technical information:

Trox Aurator AS has an origin guarantee on the electricity we use, which guarantees that all electricity used is 100% renewable.

LCA: Scenarios and additional technical information

The following information describe the scenarios in the different modules of the EPD.

Transport from production place to user (A4)	Capacity utilisation (incl. return) %	Distance (km)	Fuel/Energy Consumption	Unit	Value (Liter/tonne)
Truck, 16-32 tonnes, EURO 6 (km)	36,7 %	300	0,043	l/tkm	12,90
De-construction demolition (C1)					
	Unit	Value			
Demolition of building per kg of ventilation product (kg)	kg/DU	7,48			
Transport to waste processing (C2)					
	Capacity utilisation (incl. return) %	Distance (km)	Fuel/Energy Consumption	Unit	Value (Liter/tonne)
Truck, 16-32 tonnes, EURO 6 (km)	36,7 %	85	0,043	l/tkm	3,66
Waste processing (C3)					
	Unit	Value			
Materials to recycling (kg)	kg	6,18			
Waste treatment per kg Plastics, from incineration (kg)	kg	0,53			
Waste treatment per kg Polyethylene (PE), incineration (kg)	kg	0,03			
Waste treatment per kg Rubber, municipal incineration with fly ash extraction (kg)	kg	0,02			
Disposal (C4)					
	Unit	Value			
Landfilling of ashes from incineration of Plastics, process per kg ashes and residues (kg)	kg	0,01			
Landfilling of ashes from incineration of Polyethylene (PE), process per kg ashes and residues (kg)	kg	0,00			
Landfilling of ashes from incineration of Rubber, municipal incineration with fly ash extraction (kg)	kg	0,00			
Waste, plastic, mixture, to landfill (kg)	kg	0,03			
Waste, scrap steel, to landfill (kg)	kg	0,69			
Benefits and loads beyond the system boundaries (D)					
	Unit	Value			
Substitution of electricity, in Norway (MJ)	MJ	0,08			
Substitution of primary steel with net scrap (kg)	kg	4,36			
Substitution of thermal energy, district heating, in Norway (MJ)	MJ	1,15			

LCA: Results

The LCA results are presented below for the declared unit defined on page 2 of the EPD document.

Environmental impact									
Indicator	Unit	A1-A3	A4	C1	C2	C3	C4	D	
GWP-total	kg CO ₂ -eq	3,41E+01	4,57E-01	9,87E-03	1,29E-01	1,38E+00	6,01E-03	-4,81E+00	
GWP-fossil	kg CO ₂ -eq	3,62E+01	4,57E-01	9,86E-03	1,29E-01	1,38E+00	6,01E-03	-4,80E+00	
GWP-biogenic	kg CO ₂ -eq	-2,13E+00	1,89E-04	1,85E-06	5,36E-05	4,97E-05	2,86E-06	-2,66E-03	
GWP-luluc	kg CO ₂ -eq	3,06E-02	1,63E-04	7,77E-07	4,61E-05	2,12E-05	6,61E-07	-2,38E-03	
ODP	kg CFC11 -eq	2,96E-06	1,03E-07	2,13E-09	2,93E-08	8,38E-09	1,53E-09	-4,86E-04	
AP	mol H ⁺ -eq	3,64E-01	1,31E-03	1,03E-04	3,72E-04	1,95E-04	3,45E-05	-2,39E-02	
EP-FreshWater	kg P -eq	2,22E-03	3,65E-06	3,59E-08	1,03E-06	8,38E-07	2,72E-08	-2,96E-04	
EP-Marine	kg N -eq	4,14E-02	2,60E-04	4,55E-05	7,36E-05	7,40E-05	1,62E-05	-4,95E-03	
EP-Terrestrial	mol N -eq	1,21E+00	2,90E-03	5,00E-04	8,23E-04	7,42E-04	1,47E-04	-5,06E-02	
POCP	kg NMVOC -eq	1,46E-01	1,11E-03	1,37E-04	3,15E-04	1,82E-04	4,21E-05	-2,41E-02	
ADP-minerals&metals ¹	kg Sb-eq	3,04E-02	1,26E-05	1,51E-08	3,57E-06	3,38E-07	2,88E-08	-8,29E-05	
ADP-fossil ¹	MJ	4,84E+02	6,91E+00	1,36E-01	1,96E+00	2,24E-01	1,03E-01	-4,05E+01	
WDP ¹	m ³	2,40E+03	6,68E+00	2,88E-02	1,89E+00	8,71E-01	2,68E-01	2,48E+02	







GWP-total = Global Warming Potential total; GWP-fossil = Global Warming Potential fossil fuels; GWP-biogenic = Global Warming Potential biogenic; GWP-luluc = Global Warming Potential land use and land use change; ODP = Depletion potential of the stratospheric ozone layer; AP = Acidification potential, Accumulated Exceedance; EP-freshwater = Eutrophication potential, fraction of nutrients reaching freshwater end compartment; EP-marine = Eutrophication potential, fraction of nutrients reaching marine end compartment; EP-terrestrial = Eutrophication potential, Accumulated Exceedance; POCP = Formation potential of tropospheric ozone; ADP-minerals&metals = Abiotic depletion potential for non-fossil resources; ADP-fossil = Abiotic depletion for fossil resources potential; WDP = Water (user) deprivation potential, deprivation-weighted water consumption

"Reading example: 9,0 E-03 = 9,0*10⁻³ = 0,009"

*INA Indicator Not Assessed

1. The results of this environmental impact indicator shall be used with care as the uncertainties on these results are high or as there is limited experienced with the indicator

Remarks to environmental impacts





Additional environmental impact indicators									
Indicator	Unit	A1-A3	A4	C1	C2	C3	C4	D	
 PM	Disease incidence	3,59E-06	2,80E-08	2,73E-09	7,92E-09	1,07E-09	6,82E-10	-4,02E-07	
 IRP ²	kgBq U235 -eq	1,87E+00	3,02E-02	5,82E-04	8,55E-03	8,58E-04	4,47E-04	1,66E-02	
 ETP-fw ¹	CTUe	1,38E+03	5,12E+00	7,42E-02	1,45E+00	3,39E+00	5,71E-02	-2,68E+02	
 HTP-c ¹	CTUh	1,99E-07	0,00E+00	0,00E+00	0,00E+00	1,05E-10	4,00E-12	-2,31E-08	
 HTP-nc ¹	CTUh	1,86E-06	5,59E-09	6,70E-11	1,58E-09	2,26E-09	3,80E-11	5,01E-07	
 SQP ¹	dimensionless	2,46E+02	4,83E+00	1,72E-02	1,37E+00	4,45E-02	3,72E-01	-3,66E+00	

PM = Particulate Matter emissions; IRP = Ionizing radiation – human health; ETP-fw = Eco toxicity – freshwater; HTP-c = Human toxicity – cancer effects; HTP-nc = Human toxicity – non cancer effects; SQP = Potential Soil Quality Index (dimensionless)

"Reading example: 9,0 E-03 = 9,0*10⁻³ = 0,009"

*INA Indicator Not Assessed

1. The results of this environmental impact indicator shall be used with care as the uncertainties on these results are high or as there is limited experienced with the indicator
2. This impact category deals mainly with the eventual impact of low dose ionizing radiation on human health of the nuclear fuel cycle. It does not consider effects due to possible nuclear accidents, occupational exposure nor due to radioactive waste disposal in underground facilities. Potential ionizing radiation from the soil, from radon and from some construction materials is also not measured by this indicator.

Resource use									
Indicator	Unit	A1-A3	A4	C1	C2	C3	C4	D	
 PERE	MJ	8,27E+01	9,89E-02	7,34E-04	2,80E-02	2,13E-02	1,83E-03	-3,87E+00	
 PERM	MJ	2,38E+01	0,00E+00	0,00E+00	0,00E+00	0,00E+00	0,00E+00	0,00E+00	
 PERT	MJ	1,06E+02	9,89E-02	7,34E-04	2,80E-02	2,13E-02	1,83E-03	-3,87E+00	
 PENRE	MJ	4,81E+02	6,91E+00	1,36E-01	1,96E+00	2,24E-01	1,03E-01	-4,05E+01	
 PENRM	MJ	1,62E+01	0,00E+00	0,00E+00	0,00E+00	0,00E+00	0,00E+00	0,00E+00	
 PENRT	MJ	4,97E+02	6,91E+00	1,36E-01	1,96E+00	2,24E-01	1,03E-01	-4,05E+01	
 SM	kg	4,14E+00	0,00E+00	6,67E-05	0,00E+00	0,00E+00	0,00E+00	0,00E+00	
 RSF	MJ	2,13E+00	3,54E-03	1,81E-05	1,00E-03	5,35E-04	3,84E-05	1,73E-01	
 NRSF	MJ	7,57E-02	1,26E-02	2,66E-04	3,58E-03	0,00E+00	2,97E-04	5,01E+00	
 FW	m ³	5,19E-01	7,38E-04	6,99E-06	2,09E-04	4,50E-04	1,27E-04	-1,08E-02	

PERE = Use of renewable primary energy excluding renewable primary energy resources used as raw materials; PERM = Use of renewable primary energy resources used as raw materials; PERT = Total use of renewable primary energy resources; PENRE = Use of non renewable primary energy excluding non-renewable primary energy resources used as raw materials; PENRM = Use of non renewable primary energy resources used as raw materials; PENRT = Total use of non renewable primary energy resources; SM = Use of secondary materials; RSF = Use of renewable secondary fuels; NRSF = Use of non-renewable secondary fuels; FW = Net use of fresh water

"Reading example: 9,0 E-03 = 9,0*10⁻³ = 0,009"

*INA Indicator Not Assessed

End of life - Waste									
Indicator	Unit	A1-A3	A4	C1	C2	C3	C4	D	
	HWD	kg	2,88E-01	3,56E-04	4,00E-06	1,01E-04	0,00E+00	1,67E-03	-2,49E-02
	NHWD	kg	1,33E+01	3,36E-01	1,61E-04	9,52E-02	0,00E+00	7,14E-01	-1,96E+00
	RWD	kg	1,78E-03	4,70E-05	9,43E-07	1,33E-05	0,00E+00	4,70E-08	1,27E-05

HWD = Hazardous waste disposed; NHWD = Non-hazardous waste disposed; RWD = Radioactive waste disposed

*Reading example: 9,0 E-03 = $9,0 \cdot 10^{-3} = 0,009$

*INA Indicator Not Assessed

End of life - Output flow									
Indicator	Unit	A1-A3	A4	C1	C2	C3	C4	D	
	CRU	kg	0,00E+00	0,00E+00	0,00E+00	0,00E+00	0,00E+00	0,00E+00	0,00E+00
	MFR	kg	1,90E+00	0,00E+00	6,55E-05	0,00E+00	6,18E+00	2,24E-06	0,00E+00
	MER	kg	9,09E-09	0,00E+00	2,03E-07	0,00E+00	4,50E-02	5,48E-08	0,00E+00
	EEE	MJ	7,85E-08	0,00E+00	6,96E-07	0,00E+00	7,59E-02	3,56E-06	0,00E+00
	EET	MJ	1,19E-06	0,00E+00	1,05E-05	0,00E+00	1,15E+00	5,38E-05	0,00E+00

CRU = Components for re-use; MFR = Materials for recycling; MER = Materials for energy recovery; EEE = Exported energy electrical; EET = Exported energy thermal

*Reading example: 9,0 E-03 = $9,0 \cdot 10^{-3} = 0,009$

*INA Indicator Not Assessed

Biogenic Carbon Content		
Indicator	Unit	At the factory gate
Biogenic carbon content in product	kg C	0,00E+00
Biogenic carbon content in accompanying packaging	kg C	7,65E-01

Note: 1 kg biogenic carbon is equivalent to 44/12 kg CO₂

Additional requirements

Greenhouse gas emissions from the use of electricity in the manufacturing phase

National production mix from import, low voltage (production of transmission lines, in addition to direct emissions and losses in grid) of applied electricity for the manufacturing process (A3).

Electricity mix	Source	Amount	Unit
Electricity, Norway (kWh)	ecoinvent 3.6	24,33	g CO ₂ -eq/kWh

Dangerous substances

The product contains no substances given by the REACH Candidate list.

Indoor environment

Additional Environmental Information

Additional environmental impact indicators required in NPCR Part A for construction products								
Indicator	Unit	A1-A3	A4	C1	C2	C3	C4	D
GWPIOBC	kg CO ₂ -eq	3,69E+01	4,57E-01	9,87E-03	1,29E-01	1,38E+00	7,56E-03	-7,19E+00

GWPI-IOBC: Global warming potential calculated according to the principle of instantaneous oxidation. In order to increase the transparency of biogenic carbon contribution to climate impact, the indicator GWP-IOBC is required as it declares climate impacts calculated according to the principle of instantaneous oxidation. GWP-IOBC is also referred to as GWP-GHG in context to Swedish public procurement legislation.

Bibliography

ISO 14025:2010 Environmental labels and declarations - Type III environmental declarations - Principles and procedures.

ISO 14044:2006 Environmental management - Life cycle assessment - Requirements and guidelines.

EN 15804:2012+A2:2019 Environmental product declaration - Core rules for the product category of construction products.

ISO 21930:2017 Sustainability in buildings and civil engineering works - Core rules for environmental product declarations of construction products.





ecoinvent v3, Allocation, cut-off by classification, Swiss Centre of Life Cycle Inventories.

Iversen et al., (2021) eEPD v2021.09 Background information for EPD generator tool system verification, LCA.no Report number: 07.21

Graafland and Iversen (2022) EPD generator for NPCR 030 Ventilation components, Background information for EPD generator application and LCA data, LCA.no report number: 12.22

NPCR Part A: Construction products and services. Ver. 2.0. April 2021, EPD-Norge.

NPCR 030 Part B for Ventilation components, Ver. 1.0, 18.05.2021, EPD Norway.

 <small>Global program operator</small>	Program operator and publisher The Norwegian EPD Foundation Post Box 5250 Majorstuen, 0303 Oslo, Norway	Phone: +47 977 22 020 e-mail: post@epd-norge.no web: www.epd-norge.no
	Owner of the declaration: TROX Auranor AS Auranorvegen 6, 2770 Jaren	Phone: +47 61 31 35 00 e-mail: office-no@troxgroup.com web: https://www.trox.no/
	Author of the Life Cycle Assessment LCA.no AS Dokka 6A, 1671	Phone: +47 916 50 916 e-mail: post@lca.no web: www.lca.no
	Developer of EPD generator LCA.no AS Dokka 6B, 1671 Kråkerøy	Phone: +47 916 50 916 e-mail: post@lca.no web: www.lca.no
	ECO Platform ECO Portal	web: www.eco-platform.org web: ECO Portal