

# Environmental Product Declaration

In accordance with ISO14025:2006 and EN15804:2012+A2:2019

## Aluminium bolts for window and door solutions

Production at Spilka

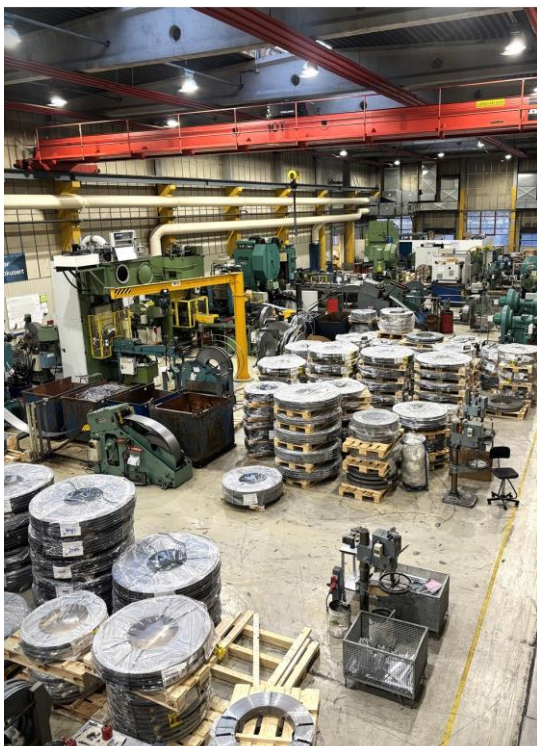

Typical components covered by this EPD

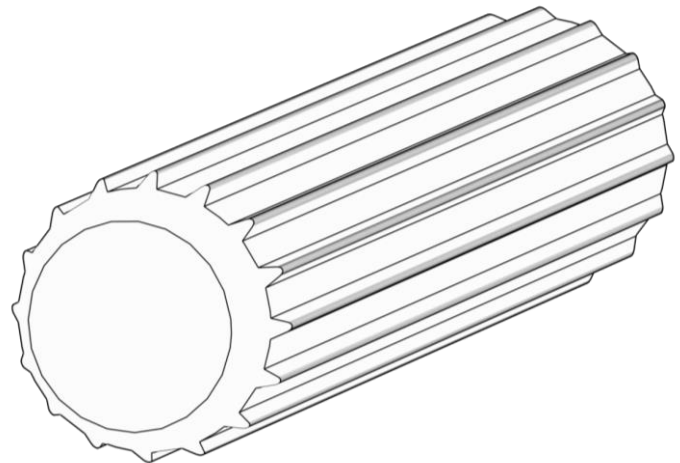

**Owner of the declaration:**  
A/S Spilka Industri

**Product name:**  
Aluminium bolts for window and door solutions

**Declared unit:**  
1 kg

**Product category /PCR:**  
EN 15804:2012+A2:2019 serves as core-PCR og NPCR 013 Part B for Steel and Aluminium Construction Products

**Program holder and publisher:**  
The Norwegian EPD foundation

**Declaration number:**  
NEPD-8699-8360-EN

**Registration number:**  
NEPd-8699-8360-EN

**Issue date:**  
13.01.2025

**Valid to:**  
13.01.2030

# General information

## Product:

Aluminium bolts for window and door solutions

## Program operator:

The Norwegian EPD Foundation  
Post Box 5250 Majorstuen, 0303 Oslo, Norway  
Phone: +47 23 08 80 00  
e-mail: post@epd-norge.no

## Declaration number:

NEPD-8699-8360-EN

## This declaration is based on Product Category Rules:

NPCR 013 Part B for Steel and Aluminium Construction Products

## Statement of liability:

The owner of the declaration shall be liable for the underlying information and evidence. EPD Norway shall not be liable with respect to manufacturer, life cycle assessment data and evidences.

## Declared unit:

1 kg of aluminum bolts for window and door solutions

## Functional unit:

Not relevant

## Verification:

Independent verification of the declaration and data, according to ISO14025:2010

internal

Sign

external



Julie Lyslo Skullestad

Independent verifier approved by EPD Norway

## Owner of the declaration:

A/S Spilka Industri

Contact person: Dag Brandal

Phone: +47 992 58 958

e-mail: dag.brandal@spilka.com

## Manufacturer:

A/S Spilka Industri

Langrabben 71, 6013 Ålesund

Phone: +47 701 76 500

e-mail: office@spilka.com

## Place of production:

Emblem, Ålesund, Norway

## Management system:

ISO 9001

## Organisation no:

916155808

## Issue date:

13.01.2025

## Valid to:

13.01.2030

## Year of study:

2023

## Comparability:

EPD of construction products may not be able to compare if they do not comply with EN 15804 and are seen in a building context.

## The EPD has been worked out by:

Sander Nørsterud, Asplan Viak AS

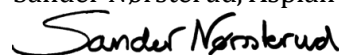

asplan  
viak



Approved



Manager of EPD Norway

## Product

### Product description:

1 kg of aluminium bolts for window and door hardware solutions.

### Product specification:

The material input per kg is given in the table below.

Materials	Share, %
Aluminium 6063	100

### Technical data:

AW 6063

### Market:

Norway, Scandinavia and Europe

### Reference service life, product:

N/A

### Reference service life, building:

N/A

## LCA: Calculation rules

### Declared unit:

1 kg of aluminium bolts for windows and door hardware solutions, modules A1-A3, A4, A5, C1-C4 and D

### Cut-off criteria:

All major raw materials and all the essential energy is included. The production process for raw materials and energy flows that are included with very small amounts (<1%) are not included. This cut-off rule does not apply for hazardous materials and substances.

### Allocation:

The allocation is made in accordance with the provisions of EN 15804+A2:2019. Incoming energy and water and waste production in-house is allocated equally among all products through mass allocation. Effects of primary production of recycled materials are allocated to the main product in which the material was used.

### Data quality:

Data was collected during autumn 2024 and is representative for the year 2023 (yearly average). Data for raw material inputs, manufacturing of the product and transport to market (A1-A3 and A4) is based on specific data provided by Spilka and technical data sheets from the suppliers. End of Life (C1-C4) scenarios are uncertain and conservative assumptions have therefore been applied. Generic data for background processes has been modelled using ecoinvent 3.9.1. Characterization factors from EN15804: 2012 + A2: 2019.

System boundaries (X=included, MND=module not declared, MNR=module not relevant)

Product stage			Assembly stage		Use stage								End of life stage				Benefits & loads beyond system boundary
Raw materials	Transport	Manufacturing	Transport	Assembly	Use	Maintenance	Repair	Replacement	Refurbishment	Operational energy use	Operational water use	De-construction demolition	Transport	Waste processing	Disposal	Reuse-Recovery-Recycling-potential	
A1	A2	A3	A4	A5	B1	B2	B3	B4	B5	B6	B7	C1	C2	C3	C4	D	
X	X	X	X	X	MND	MND	MND	MND	MND	MND	MND	X	X	X	X	X	

### System boundary:

The system boundary is from cradle to gate with options, A1-A3, A4, A5, C1-C4 and D. The flow chart for production, transport and end of life is shown in the figure below.

System boundary

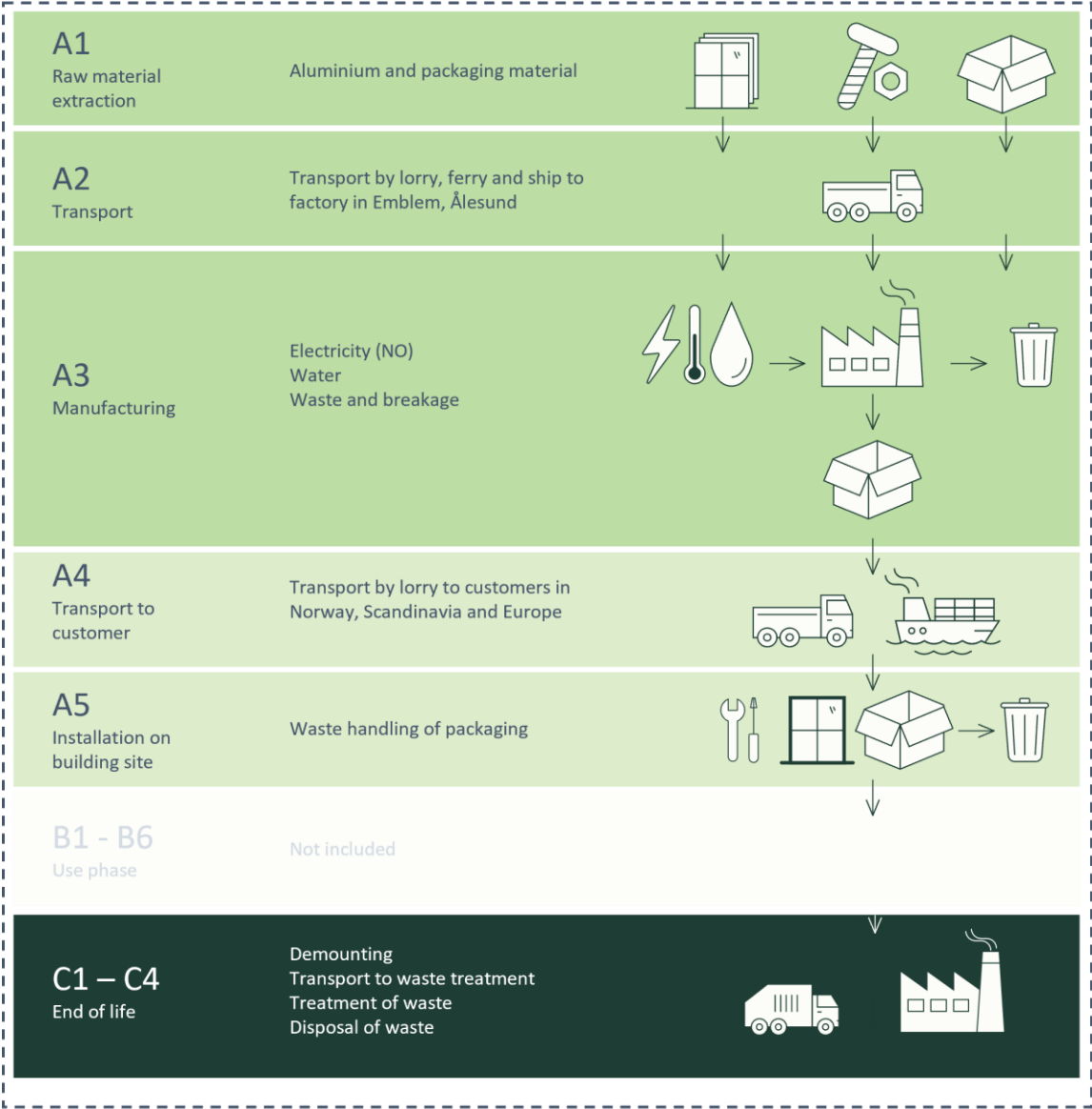

**D**  
Benefits outside system boundary

Recycling and energy recovery



## LCA: Scenarios and additional technical information

The following information describe the scenarios in the different modules of the EPD.

Scenarios have been developed for transportation from manufacturing to market (A4) and to account for downstream for waste treatment in accordance with the requirements of EN 15804 and NPCR PART A.

### Transport from production place to assembly/user (A4)

The environmental impacts of transportation to market (A4) are calculated for three different markets: Norway (main scenario), Scandinavia and Europe.

Type	Capacity utilisation (incl. return) %	Type of vehicle	Distance KM	Fuel/Energy consumption	value (l/t)
Scenario 1: Norway					
Truck	50 %	Lorry, EURO 6, 24 ton	513	0,03 l/tkm	15,4
Scenario 2: Scandinavia					
Truck	50 %	Lorry, EURO 6, 24 ton	751	0,03 l/tkm	22,5
Scenario 3: Europe					
Truck	50 %	Lorry, EURO 6, 24 ton	2080	0,03 l/tkm	62,4

Products from Spilka's manufacturing facilities are transported to customers through an extensive distribution network (Posten/Bring). Consequently, high capacity utilization is expected, with a load factor of 50% considered likely.

### Assembly (A5)

	Unit	Value
Waste treatment of packaging	kg	0,0063

### End of Life (C1, C3, C4)

	Unit	Value
Recycling	kg	1
Energy recovery	kg	0
To landfill	kg	

### Transport to waste processing (C2)

Transport from production place to assembly/user (C2)	Capacity utilisation (incl. return) %	Distance (km)	Fuel/Energy consumption	Unit	Value
Truck	43	19+52+226	0,03	l/tkm	0,28

The transport distances are based on Raadal et al. (2009) and include transport to waste center, further on to central sorting facility and finally to waste handling facility.

## Benefits and loads beyond the system boundaries (D)

Benefits and loads beyond the system boundaries (D)	Unit	Value
Substitution of electricity, in Norway	MJ	0,00
Substitution of thermal energy, district heating, in Norway	MJ	0,00
Net new steel scrap	kg	0,00
Net new aluminium scrap	kg	0,89

## LCA: Results

The LCA results for the declared unit of 1 kg of aluminium bolts for window and door solutions, modules A1-A3, A4, A5, C1-C4 and D, are presented below. The results are an average of aluminium bolts 40, 90 and 120 mm sold by Spilka. The A1-A3 GWP results for the different products grouped together are within +/- 10 % of the average given in the results, as given in the General Programme Instructions (GPI) by EPD-Norway.

The results for the scenario A4 Transport to market are given for the Norwegian market. See "Additional results" for results for different A4 scenarios.

### Core environmental impact indicators

Indicator	Unit	A1-A3	A4	A5	C1	C2	C3	C4	D
GWP - total	kg CO2 eq	1,9E+01	6,3E-02	2,3E-02	0,0E+00	8,1E-02	1,6E-02	5,1E-05	-1,4E+01
GWP - fossil	kg CO2 eq	1,9E+01	6,3E-02	1,3E-02	0,0E+00	8,1E-02	1,6E-02	5,3E-05	-1,4E+01
GWP - biogenic	kg CO2 eq	-1,3E-01	9,9E-05	1,0E-02	0,0E+00	1,6E-04	1,4E-04	-1,8E-06	5,6E-02
GWP - luluc	kg CO2 eq	5,1E-03	1,8E-05	1,1E-04	0,0E+00	2,8E-05	5,7E-06	1,6E-07	-2,4E-03
ODP	kg CFC11 eq	1,3E-07	1,4E-09	1,5E-10	0,0E+00	1,6E-09	2,8E-13	1,3E-16	-1,0E-07
AP	molc H+ eq	1,2E-01	1,3E-04	2,5E-05	0,0E+00	2,4E-04	3,8E-05	3,7E-07	-1,3E-01
EP - freshwater	kg P eq	4,2E-04	3,6E-07	6,0E-07	0,0E+00	4,7E-07	5,9E-08	1,1E-10	-7,7E-04
EP -marine	kg N eq	2,1E-02	3,6E-05	3,4E-05	0,0E+00	8,9E-05	9,6E-06	9,7E-08	-1,6E-02
EP - terrestrial	molc N eq	2,3E-01	3,7E-04	6,5E-05	0,0E+00	9,5E-04	1,0E-04	1,1E-10	-1,7E-01
POCP	kg NMVOC eq	6,7E-02	2,3E-04	1,9E-05	0,0E+00	4,6E-04	2,5E-05	2,9E-07	-5,3E-02
ADP-M&M <sup>2</sup>	kg Sb-Eq	4,5E-05	8,4E-08	3,7E-08	0,0E+00	1,8E-07	2,4E-09	2,4E-12	-8,2E-06
ADP-fossil <sup>2</sup>	MJ	1,6E+02	9,1E-01	5,5E-02	0,0E+00	1,1E+00	3,3E-01	7,0E-04	-1,3E+02
WDP <sup>2</sup>	m <sup>3</sup>	2,5E+00	3,3E-03	2,7E-03	0,0E+00	3,5E-03	3,4E-03	5,8E-06	-9,5E-01

**GWP-total:** Global Warming Potential; **GWP-fossil:** Global Warming Potential fossil fuels; **GWP-biogenic:** Global Warming Potential biogenic; **GWP-LULUC:** Global Warming Potential land use and land use change; **ODP:** Depletion potential of the stratospheric ozone layer; **AP:** Acidification potential, Accumulated Exceedance; **EP-freshwater:** Eutrophication potential, fraction of nutrients reaching freshwater end compartment; See "additional Norwegian requirements" for indicator given as PO4 eq. **EP-marine:** Eutrophication potential, fraction of nutrients reaching freshwater end compartment; **EP-terrestrial:** Eutrophication potential, Accumulated Exceedance; **POCP:** Formation potential of tropospheric ozone; **ADP-M&M:** Abiotic depletion potential for non-fossil resources (minerals and metals); **ADP-fossil:** Abiotic depletion potential for fossil resources; **WDP:** Water deprivation potential, deprivation weighted water consumption

Reading example: 9,0 E-03 = 9,0\*10<sup>-3</sup> = 0,009

### Additional environmental impact indicators

Indicator	Unit	A1-A3	A4	A5	C1	C2	C3	C4	D
PM	Disease incidence	1,5E-06	4,0E-09	2,7E-10	0,0E+00	6,2E-09	0,0E+00	0,0E+00	-6,6E-07
IRP <sup>1</sup>	kBq U235 eq.	8,9E-02	3,8E-04	1,2E-04	0,0E+00	4,3E-04	0,0E+00	0,0E+00	-2,7E-01
ETP-fw <sup>2</sup>	CTUe	4,5E+01	4,7E-01	8,7E-02	0,0E+00	5,3E-01	0,0E+00	0,0E+00	-2,5E+01
HTP-c <sup>2</sup>	CTUh	1,8E-08	1,8E-11	2,7E-12	0,0E+00	2,7E-11	0,0E+00	0,0E+00	-1,4E-08
HTP-nc <sup>2</sup>	CTUh	4,1E-07	7,0E-10	9,1E-11	0,0E+00	8,0E-10	0,0E+00	0,0E+00	-3,1E-07
SQP <sup>2</sup>	Dimensionless	4,3E+01	7,9E-01	3,0E-02	0,0E+00	4,7E-01	0,0E+00	0,0E+00	-2,3E+01

**PM:** Particulate matter emissions; **IRP:** Ionising radiation, human health; **ETP-fw:** Ecotoxicity (freshwater); **ETP-c:** Human toxicity, cancer effects; **HTP-nc:** Human toxicity, non-cancer effects; **SQP:** Land use related impacts / soil quality

<sup>1</sup> This impact category deals mainly with the eventual impact of low dose ionizing radiation on human health of the nuclear fuel cycle. It does not consider effects due to possible nuclear accidents, occupational exposure nor due to radioactive waste disposal in underground facilities. Potential ionizing radiation from the soil, from radon and from some construction materials is also not measured by this indicator.

<sup>2</sup> The results of this environmental impact indicator shall be used with care as the uncertainties on these results are high or as there is limited experienced with the indicator



## Resource use

Parameter	Unit	A1-A3	A4	A5	C1	C2	C3	C4	D
RPEE	MJ	1,3E+01	1,1E-02	2,2E-02	0,0E+00	1,3E-02	1,9E-01	1,2E-04	-2,4E+00
RPEM	MJ	6,1E-02	0,0E+00	0,0E+00	0,0E+00	0,0E+00	0,0E+00	0,0E+00	0,0E+00
TPE	MJ	1,3E+01	1,1E-02	2,2E-02	0,0E+00	1,3E-02	1,9E-01	1,2E-04	-2,4E+00
NRPE	MJ	1,6E+02	9,1E-01	5,5E-02	0,0E+00	1,1E+00	3,3E-01	7,0E-04	-1,3E+02
NRPM	MJ	6,5E-02	0,0E+00	0,0E+00	0,0E+00	0,0E+00	0,0E+00	0,0E+00	0,0E+00
TRPE	MJ	1,6E+02	9,1E-01	5,5E-02	0,0E+00	1,1E+00	3,3E-01	7,0E-04	-1,3E+02
SM	kg	3,0E-01	0,0E+00	0,0E+00	0,0E+00	0,0E+00	0,0E+00	0,0E+00	0,0E+00
RSF	MJ	0,0E+00	0,0E+00	0,0E+00	0,0E+00	0,0E+00	0,0E+00	0,0E+00	0,0E+00
NRSF	MJ	0,0E+00	0,0E+00	0,0E+00	0,0E+00	0,0E+00	0,0E+00	0,0E+00	0,0E+00
W	m <sup>3</sup>	8,6E-02	1,1E-04	1,7E-04	0,0E+00	1,5E-04	1,6E-04	1,8E-07	-2,7E-02

**RPEE** Renewable primary energy resources used as energy carrier; **RPEM** Renewable primary energy resources used as raw materials; **TPE** Total use of renewable primary energy resources; **NRPE** Nonrenewable primary energy resources used as energy carrier; **NRPM** Nonrenewable primary energy resources used as materials; **TRPE** Total use of non-renewable primary energy resources; **SM** Use of secondary materials; **RSF** Use of renewable secondary fuels; **NRSF** Use of non-renewable secondary fuels; **W** Use of net fresh water.

## End of life – Waste

Parameter	Unit	A1-A3	A4	A5	C1	C2	C3	C4	D
HW	kg	1,5E-02	1,9E-05	1,0E-04	0,0E+00	2,1E-05	-2,5E-11	1,5E-14	-4,5E-03
NHW	kg	3,1E+00	6,8E-02	2,8E-03	0,0E+00	3,8E-02	4,4E-02	3,5E-03	-2,3E+00
RW	kg	5,1E-05	2,4E-07	7,1E-08	0,0E+00	2,7E-07	5,0E-05	8,1E-09	-1,7E-04

**HW** Hazardous waste disposed; **NHW** Non-hazardous waste disposed; **RW** Radioactive waste disposed.

## End of life – output flow

Parameter	Unit	A1-A3	A4	A5	C1	C2	C3	C4	D
CR	kg	0,0E+00	0,0E+00	0,0E+00	0,0E+00	0,0E+00	0,0E+00	0,0E+00	0,0E+00
MR	kg	3,7E-03	0,0E+00	0,0E+00	0,0E+00	0,0E+00	1,7E+00	0,0E+00	0,0E+00
MER	kg	2,9E-03	0,0E+00	0,0E+00	0,0E+00	0,0E+00	0,0E+00	0,0E+00	0,0E+00
EEE	MJ	0,0E+00	0,0E+00	4,6E-02	0,0E+00	0,0E+00	0,0E+00	0,0E+00	0,0E+00
ETE	MJ	0,0E+00	0,0E+00	1,4E+00	0,0E+00	0,0E+00	0,0E+00	0,0E+00	0,0E+00

**CR** Components for reuse; **MR** Materials for recycling; **MER** Materials for energy recovery; **EEE** Exported electric energy; **ETE** Exported thermal energy.

## Information describing the biogenic carbon content at the factory gate

Biogenic carbon content	Unit	Value
Biogenic carbon content in product	kg C	0
Biogenic carbon content in the accompanying packaging	kg C	4,13E-03

## Additional requirements

### Location based electricity mix from the use of electricity in manufacturing

National production mix from import, low voltage (production of transmission lines, in addition to direct emissions and losses in grid) of applied electricity for the manufacturing process (foreground/core) per functional unit.

National electricity grid	Data source	Foreground / core [kWh]	GWP <sub>total</sub> [kg CO <sub>2</sub> - eq/kWh]	SUM [kg CO <sub>2</sub> - eq]
Electricity, low voltage {NO}  market for electricity, medium voltage   Cut-off, U	ecoinvent v. 3.9.1	1,12	0,039	0,044

### Additional environmental impact indicators required for construction products

In order to increase the transparency of biogenic carbon contribution to climate impact, the indicator GWP-IOBC is required as it declares climate impacts calculated according to the principle of instantaneous oxidation. GWP-IOBC is also referred to as GWP-GHG in context to Swedish public procurement legislation.

Parameter	Unit	A1-A3	A4	A5	C1	C2	C3	C4	D
GWP-IOBC	kg	1,9E+01	6,3E-02	7,7E-03	0,0E+00	8,1E-02	1,6E-02	5,1E-05	-1,4E+01

*GWP-IOBC Global warming potential calculated according to the principle of instantaneous oxidation.*

### Hazardous substances

The declaration is based upon reference to threshold values and/or test results and/or material safety data sheets provided to EPD verifiers. Documentation available upon request to EPD owner.

- The product contains no substances given by the REACH Candidate list.
- The product contains substances given by the REACH Candidate list that are less than 0,1 % by weight. See table below.
- The product contains dangerous substances, more then 0,1% by weight, given by the REACH Candidate List, see table below.
- The product contains no substances given by the REACH Candidate list.
- The product is classified as hazardous waste, see table.

### Indoor environment

The product meets the requirements for low emissions.

### Carbon footprint

While a carbon footprint analysis has not been conducted for the product separately, the results section does include an evaluation of Global Warming Potential (GWP) with such an analysis. The GWP total results presented in this EPD document represents the carbon footprint of the product studied.

## Additional results

---

Below the GWP-total results for the different transport to market (A4) scenarios are shown.





### Results for A4 – Transport to market scenarios

To calculate the results for the Scandinavian market (scenario 2) or the European market (scenario 3), simply substitute the value for A4 in the main results with the results for the scenarios in the table below.

Transport to market of 1 kg product				
	Unit	Scenario 1: Norway	Scenario 2: Scandinavia	Scenario 3: Europe
GWP-total	kg CO2 eq.	0,0626	0,0917	0,254

## Bibliography

ISO 14025:2010	Environmental labels and declarations - Type III environmental declarations - Principles and procedures
ISO 14044:2006	Environmental management - Life cycle assessment - Requirements and guidelines
EN 15804:2012+A2:2019	Sustainability of construction works - Environmental product declaration - Core rules for the product category of construction products
ecoinvent v. 3	Allocation, cut-off by classification, Swiss Centre of Life Cycle Inventories
ISO 21930:2007	Sustainability in building construction - Environmental declaration of building products
EPD-Norge (2021)	NPCR Part A: Construction products and services ver. 2.0 24.03.2021
EPD-Norge (2021)	NPCR 013 :Part B for Steel and Aluminium Construction Products ver. 4.0 06.10.2021
LCA Report	Life Cycle Assessment report of door and window hardware products from Spilka Industri, Sander Nørsterud (2024)
SSAB (2020)	S-P-01919 v. 1.2 Hot rolled steel sheets and coils
Hydro Extrusion Norway (2024)	S-P-11243 Mill Finished Profile implemented with the average billet purchased
Hydro Extrusion Norway (2024)	S-P-11874 Anodised aluminium profile implemented with the average billet purchased
Hydro Extrusion Norway (2024)	S-P-11877 Painted aluminium profile implemented with average billet purchased

	<b>Program Operator</b>	tlf	+47 23 08 80 00
	Post Box 5250 Majorstuen, 0303 Oslo Norway	e-post:	post@epd-norge.no
		web	www.epd-norge.no
	<b>Publisher</b>	tlf	+47 23 08 80 00
	Post Box 5250 Majorstuen, 0303 Oslo Norway	e-post:	post@epd-norge.no
		web	www.epd-norge.no
	<b>Owner of the declaration</b>	tlf	+47 701 76 500
	A/S Spilka Industri	e-post:	office@spilka.com
	Langrabben 71, 6013 Ålesund	web	<a href="http://www.spilka-dws.com/no/">www.spilka-dws.com/no/</a>
	<b>Author of the life cycle assesment</b>	tlf	+47 41 79 94 17
	Postboks 24, 1300 Sandvika Norway	e-post:	<a href="mailto:asplanviak@asplanviak.no">asplanviak@asplanviak.no</a>
		web	<a href="http://www.asplanviak.no">www.asplanviak.no</a>
	ECO Platform ECO Portal	web	<a href="http://www.eco-platform.org">www.eco-platform.org</a>
		web	<a href="http://www.eco-platform.org">ECO Portal</a>